

USER MANUAL

MODEL 2040 Series
V.35/RS-422 to HSSI
Interface Converter

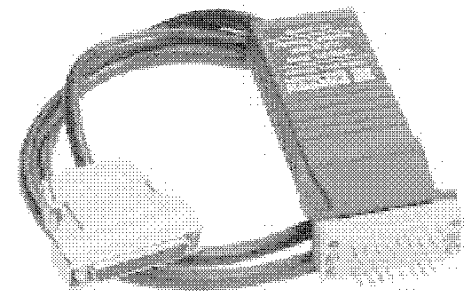

*An ISO-9001
Certified Company*

1.0 WARRANTY INFORMATION

Patton Electronics warrants all Model 2040 components to be free from defects, and will—at our option—repair or replace the product should it fail within one year from the first date of shipment.

This warranty is limited to defects in workmanship or materials, and does not cover customer damage, abuse or unauthorized modification. If this product fails or does not perform as warranted, your sole recourse shall be repair or replacement as described above. Under no condition shall Patton Electronics be liable for any damages incurred by the use of this product. These damages include, but are not limited to, the following: lost profits, lost savings and incidental or consequential damages arising from the use of or inability to use this product. Patton Electronics specifically disclaims all other warranties, expressed or implied, and the installation or use of this product shall be deemed an acceptance of these terms by the user.

1.1 RADIO AND TV INTERFERENCE

The Model 2040 generates and uses radio frequency energy, and if not installed and used properly—that is, in strict accordance with the manufacturer's instructions—may cause interference to radio and television reception. The Model 2040 has been tested and found to comply with the limits for a Class A computing device in accordance with the specifications in Subpart J of Part 15 of FCC rules, which are designed to provide reasonable protection from such interference in a commercial installation. However, there is no guarantee that interference will not occur in a particular installation. If the Model 2040 does cause interference to radio or television reception, which can be determined by disconnecting the Model 2040, the user is encouraged to try to correct the interference by one or more of the following measures: moving the computing equipment away from the receiver, re-orienting the receiving antenna and/or plugging the receiving equipment into a different AC outlet (such that the computing equipment and receiver are on different branches).

1.2 CE NOTICE

The CE symbol on your Patton Electronics equipment indicates that it is in compliance with the Electromagnetic Compatibility (EMC) directive and the Low Voltage Directive (LVD) of the Union European (EU). A Certificate of Compliance is available by contacting Technical Support.

1.3 SERVICE

All warranty and nonwarranty repairs must be returned freight prepaid and insured to Patton Electronics. All returns must have a Return Materials Authorization number on the outside of the shipping container. This number may be obtained from Patton Electronics Technical Service at (301) 975-1007, <http://www.patton.com>, or at support@patton.com.

NOTE: Packages received without an RMA number will not be accepted.

Patton Electronics' technical staff is also available to answer any questions that might arise concerning the installation or use of your Model 2040. Technical Service hours: **8AM to 5PM EST, Monday through Friday.**

2.0 GENERAL INFORMATION

Thank you for your purchase of this Patton Electronics product. It has been thoroughly inspected and tested and is warranted for One Year for parts and labor. If you have any questions about this product, please call Patton Electronics Technical Support at (301) 975-1007.

2.1 FEATURES

- Bi-directionally converts V.35 or RS-422 to HSSI.
- Supports synchronous data rates up to 10Mbps.
- Transparent to synchronous protocol.
- M/34 and HD-50 connectors with integral 6-foot (1.8m) cable.
- Four versions available:
 - Model 2040MC-MT: Connects V.35 (DTE) to HSSI (DCE)
 - Model 2040MT-MC: Connects V.35 (DCE) to HSSI (DTE)
 - Model 2040MC-MT-422: Connects RS-422 (DTE) to HSSI (DCE)
 - Model 2040MT-MC-422: Connects RS-422 (DCE) to HSSI (DTE)
- Internal synchronization circuit enables high speed connections
- Externally AC powered.
- Made in the U.S.A.

2.2 DESCRIPTION

The Model 2040 is a V.35/RS-422 to High Speed Serial Interface (HSSI) converter. It allows a HSSI (HD-50) device to communicate bi-directionally with a V.35 or RS-422 device at synchronous data rates up to 10Mbps. The Model 2040 supports all HSSI co-directional timing patterns, 2 loopback modes (local and remote line), full duplex data and control signals.

The Model 2040 is available in several versions: The Model 2040MT-MC lets a V.35 DCE device communicate with a HSSI DTE device. The Model 2040MC-MT lets a V.35 DTE device communicate with a HSSI DCE device. RS-422 to HSSI versions are also available.

All versions are equipped with a male M/34 connector on the converter end, and a male HD-50 on the end of a 6-foot (1.8 m) cable. Other connector genders and cable lengths are available on a custom basis. Power is supplied to the Model 2040 by an external desktop AC transformer.

3.0 CONFIGURATION

The Model 2040 is easy to install and is ruggedly designed for excellent reliability. The following instructions will help you set up and install the Model 2040 properly.

To use the Patton Model 2040, you must first configure the unit for your application. To do so, first open the case by inserting a flat head screw driver into an open slot on either side of the case, as in Figure 1.

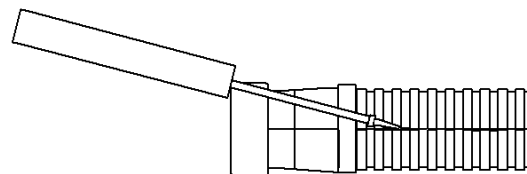

Figure 1: Using a Small Screw Driver to Open the Model 2040 Case

Twist the screw driver head slightly and the top half of the case will separate from the lower half, as in Figure 2. You now have access to the internal switches used to configure the unit.

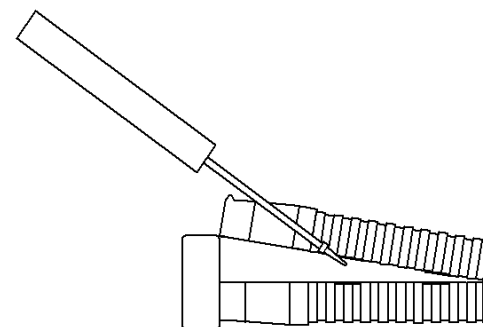

Figure 2: Using a Small Screw Driver to Open the Model 2040 Case

After opening the case, please refer to the section that pertains to your unit for configuration details:

<u>Patton Model Number</u>	<u>Section</u>
Model 2040MC-MT and 2040MC-MT-422	3.1
Model 2040MT-MC and 2040MT-MC-422	3.2

To close the case, fit the 2 halves together snugly and snap them back in place.

3.1 CONFIGURATION SWITCHES (MODELS 2040MC-MT & 2040MC-MT-422)

The Models 2040MC-MT and 2040MC-MT-422 use a mini DIP switch that may be used to configure the units to connect synchronous V.35 or RS-422 DTE equipment to synchronous HSSI DCE equipment. Each interface converter is factory configured as DCE on the V.35 or RS-422 end, and DTE on the HSSI end. Therefore, the V.35 or RS-422 end "wants" to connect to DTE and the HSSI end "wants" to connect to DCE.

Please follow the instructions in this section to configure the internal DIP switches so that the unit will work properly in your application. Figure 3 shows the position of Switch S1 on the top side of the PC board.

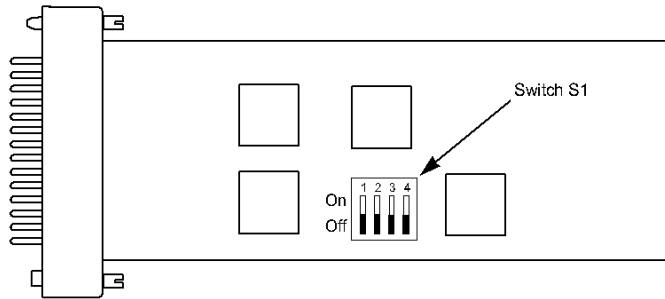

Figure 3. The Model 2040MC-MT Assembly Drawing

Figure 4 shows the orientation of the switches on DIP Switch S1 with respect to ON/OFF positions. The default settings for DIP Switch S1 are shown in Table 1 on page 6. Detailed descriptions of each switch follow the table.

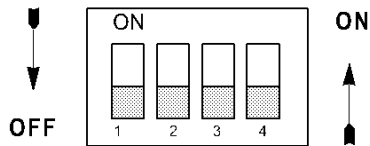

Figure 4. Close-up of DIP Switches Showing "ON" and "OFF" Positions

2040MC-MT DIP SWITCH SUMMARY TABLE		
Position	Function	Factory Default
S1-1	Clock Source	On
S1-2	Clock Source	Off
S1-3	Sync Method	Off
S1-4	Sync Method	On

Table 1. DIP Switch S1 Default Settings for Model 2040MC-MT

Switches S1-1 and S1-2: Clock Source

The setting for Switches S1-1 and S1-2 determines the source of the HSSI Terminal Timing (TT). With Switch S1-1 On and S1-2 Off, the Model 2040MC-MT derives the HSSI Terminal Timing from the ST signal provided by the HSSI DCE. With Switch S1-1 Off, and S1-2 On, the V.35 (or RS-422) DTE provides TT to the HSSI DCE.

S1-1	S1-2	Description
Off	Off	Not a Valid Setting
Off	On	Terminal Timing Supplied by V.35 (RS-422) DTE device
On	Off	Terminal Timing supplied by HSSI ST signal
On	On	Not a Valid Setting

Switches S1-3 and S1-4: Synchronization Method

Switches S1-3 and S1-4 allow the Model 2040 to compensate for timing delays when transmitting HSSI data at high speeds (greater than 2.5 Mbps). At high bit rates, set Switch S1-3 On and Switch S1-4 Off. In this setting, the V.35 or RS-422 data will be synchronized to the SD timing signal before conversion to HSSI. At lower bit rates (less than 2.5 Mbps), set Switch S1-3 Off and S1-4 On. In this setting, the V.35 (or RS-422) data bypasses the synchronization circuit and is passed straight through to the HSSI DCE.

S1-3	S1-4	Description
Off	Off	Not a Valid Setting
Off	On	Data Skips Sync Circuit
On	Off	Data passes through sync circuit.
On	On	Not a Valid Setting

3.2 CONFIGURATION SWITCHES (MODELS 2040MT-MC & 2040MT-MC-422)

The Models 2040MT-MC and 2040MT-MC-422 use a mini DIP switch that may be used to configure the units to connect synchronous V.35 or RS-422 DCE equipment to synchronous HSSI DTE equipment. Each interface converter is factory configured as DTE on the V.35 or RS-422 end, and DCE on the HSSI end. Therefore, the V.35 or RS-422 end "wants" to connect to DCE and the HSSI end "wants" to connect to DTE.

Please follow the instructions in this section to configure the internal DIP switches so that the unit will work properly in your application. Figure 5 shows the position of Switch S1 on the top side of the PC board.

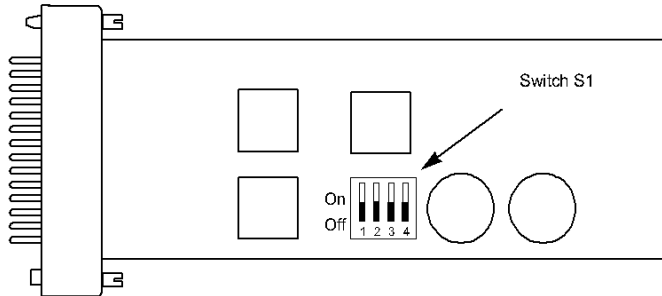

Figure 5. The Model 2040 MT-MC Assembly Drawing

Figure 6 shows the orientation of the Switches on DIP Switch S1 with respect to ON/OFF positions. The default settings for DIP switch S1 are shown in the Table 2 on page 8. Detailed descriptions of each switch follow the table.



Figure 6. Close-up of DIP Switches Showing "ON" and "OFF" Positions

2040MT-MC DIP SWITCH SUMMARY TABLE		
Position	Function	Factory Default
S1-1	Gapped Clock	On
S1-2	Gapped Clock	Off
S1-3	Sync Method	Off
S1-4	Sync Method	On

Table 2. DIP Switch S1 Default Settings for Model 2040MT-MC

Switches S1-1 and S1-2: Gapped Clock

Switches S1-1 and S1-2 allow the Model 2040MT-MC to generate a HSSI gapped clock. Gapped clocking is a method of flow control in which data flow is interrupted by an idle (gapped) clock signal. In this mode, the Model 2040MT-MC will gap the ST clock to the HSSI DTE whenever the V.35 (or RS-422) CTS signal is de-asserted. In the 'No Gapped Clock' setting, the V.35 clock passes through with only a level change.

S1-1	S1-2	Description
Off	Off	Not a Valid Setting
Off	On	Gapped Clock
On	Off	No Gapped Clock
On	On	Not a Valid Setting

Switches S1-3 and S1-4: Synchronization Method

Switches S1-3 and S1-4 allow the Model 2040MT-MC to compensate for timing delays when transmitting HSSI data at high speeds (greater than 2.5 Mbps). At high bit rates, set Switch S1-3 On and Switch S1-4 Off. In this setting, the V.35 (or RS-422) data signals will be synchronized to the SD timing signal before conversion to HSSI. At lower bit rates (less than 2.5 Mbps), set Switch S1-3 Off and S1-4 On. In this setting, the V.35 (or RS-422) data bypasses the synchronization circuit and is passed straight through to the HSSI DTE.

S1-3	S1-4	Description
Off	Off	Not a Valid Setting
Off	On	Data Skips Sync Circuit
On	Off	Data passes through sync circuit.
On	On	Not a Valid Setting

4.0 INSTALLATION

The Model 2040 is designed to connect V.35 or RS-422 devices to devices which employ the HSSI interface standard. This section describes how to install the units.

4.1 2040MC-MT CONNECTION

The Model 2040MC-MT is designed to connect a V.35 or RS-422* DTE device to an HSSI DCE device. In this application, the M/34 (V.35) and HD-50 (HSSI) male connectors of the Model 2040MC-MT may connect directly to their respective equipment ports, or they may connect via a short "straight-through" cable (See Appendix C for Interface Pin Assignments). Figure 7 below illustrates the proper connection of the Model 2040MC-MT.

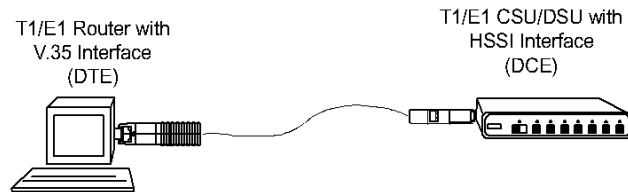

Figure 7. A Common V.35/RS-422 DTE to HSSI DCE Installation

4.2 2040MT-MC CONNECTION

The Model 2040MT-MC is designed to connect a V.35 or RS-422* DCE device to an HSSI DTE device. In this application, the M/34 (V.35) and HD-50 (HSSI) male connectors of the Model 2040MT-MC may connect directly to their respective equipment ports, or they may connect via a short "straight-through" cable (See Appendix C for Interface Pin Assignments). Figure 8 below illustrates the proper connection of the Model 2040MT-MC.

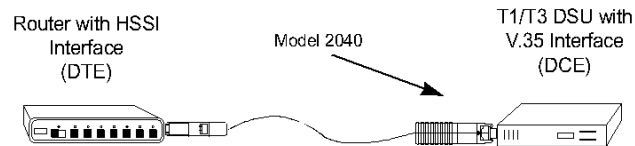

Figure 8. A Common HSSI DTE to V.35/RS-422 DCE Installation

***NOTE:** The RS-422 versions of Model 2040 use an M/34 connector. Please refer to Appendix D to construct your own cross-connect cable if your RS-422 device uses the RS-530 (DB-25) or RS-449 (DB-37) physical interface. You may also purchase cross-connect cables from Patton Electronics.

4.3 AC POWER CONNECTION

The Model 2040 uses a 5VDC, 2A universal input, power supply that is equipped with a male IEC-320 power entry connector and supports a voltage range of 100-240VAC. This transformer connects to the Model 2040 by means of a cannon jack on the rear panel. There are a variety of domestic and international power cords available for the power entry (See Appendix B). The Model 2040 is powered-up as soon as it is plugged into an AC outlet—there is no power switch.

4.4 DC POWER CONNECTION

You may bypass the DC wall adapter and supply DC power directly to the Model 2040 power supply jack. DC power supplied must be 5VDC \pm 5%, 1A minimum, center positive, and can be supplied via a barrel type plug with 2.1/5.5/10mm I.D./O.D./Shaft Length dimensions.

NOTE: DC power source must be SELV (Circuit, Safety Extra Low Voltage) specified. (See CENELEC EN60950, Section 1.2.8.5)

5.0 OPERATION

Once you have configured the Model 2040 properly (see Section 3.0) and have correctly connected DTE, DCE and power (see Section 4.0), you are ready to operate the unit. This section describes the LED status monitors and loopback test modes.

5.1 BACK PANEL LED STATUS MONITORS

The Model 2040 features two LEDs that are located on the back panel. Figure 9 below shows the positions of the LEDs. Following Figure 9 is a description of each LED.

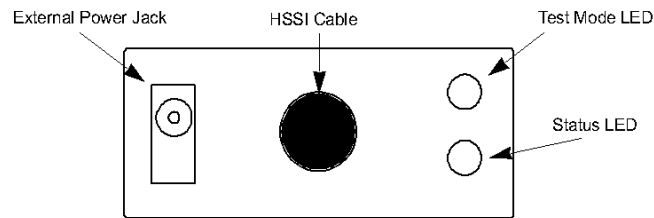

Figure 9. Model 2040 Rear Panel

Status Glows green to indicate that both DTR (from the DTE device) and DSR (from the DCE device) are active. This LED will not be illuminated whenever one of the two signals are inactive.

Test Mode Glows red to indicate that either one or both of the test modes are active (See Section 5.2 for a description of the test modes).

5.2 TEST MODES

The Model 2040 supports two loopback modes that may be used to evaluate the condition of the communication links. These modes, (Local Loopback (LL) and Remote Loopback (RL), are always **initiated by the signals on the DTE device** (See Figure 10). This section describes both loopback modes.

NOTE: HSSI supports a third loopback mode: Local Digital Loopback (LDL). However, V.35 does not support this mode. In order to use LDL, the V.35 device must be programmed to respond according to the HSSI specification for LDL (See TIA/EIA-613, Section 6.2.1 Local Digital Loopback (Loop A)).

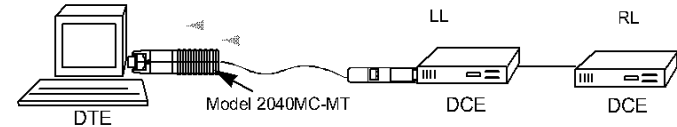

Figure 10. Local Loopback and Remote Loopback Modes

5.2.1 Local Loopback (LL)

The Local Loopback (LL) test checks the performance of the link between the DTE device and the DCE. Any data sent to the Model 2040 from the DTE in this test mode will be sent to the local DCE and will then be echoed (returned) back to the DTE (the Model 2040 simply converts and passes the data to the local DCE, which must perform the loopback). To perform a LL test, follow these steps:

- A. Verify that the data terminal equipment is operating properly and can be used for a test. If a fault is indicated, call a technician or replace the unit.
- B. Activate LL from the DTE device. This may be done either by raising pin L (if the V.35/RS-422 device is DTE), or by activating Local Loopback from the HSSI Interface (if the HSSI device is the DTE). The "test" LED should be lit.
- C. Perform a BER (bit error rate) test from the DTE. If the test indicates no fault, deactivate LL and proceed as normal.

5.2.2 Remote Digital Loopback (RL)

The Remote Loopback (RL) test checks the performance of the link between the DTE device and the DCE as well as the link between the local and remote DCE devices. Any characters sent from the DTE in this test mode will be sent to the local DCE, which will send the data to the remote DCE. The remote DCE should return the data back through the entire communication link and finally, to the DTE. To perform a RL test, follow these steps:

- A. Activate RL from the DTE device. This may be done either by raising pin N on the V.35 interface (if the V.35/RS-422 device is DTE), or by activating Local Loopback from the HSSI interface (if the HSSI device is the DTE). The "test" LED should be lit.
- B. Perform a BER (bit error rate) test from the DTE.
- C. If the BER test equipment indicates a fault, and the Local Loopback test was successful, you may have a problem with the cable between the DCE devices.

NOTE: The Model 2040 simply converts and passes the data through the communication link. The DCEs must be configured to perform to the appropriate loopback diagnostic.

APPENDIX A

MODEL 2040 SPECIFICATIONS

Data Format:	Synchronous
Data Rate:	0 - 10Mbps
Clocking:	All HSSI co-directional timing patterns are supported.
Standards:	V.35 version converts ITU/CCITT V.35 or EIA-422 to HSSI (ANSI/TIA/EIA-613 Dec. '93 and ANSI/TIA/EIA-612 NOV. '93) electrically and mechanically;
Loopbacks:	Local and Remote
Interfaces:	Model 2040MC-MT: Connects V.35 (DTE) to HSSI (DCE) Model 2040MT-MC: Connects V.35 (DCE) to HSSI (DTE) Model 2040MC-MT-422*: Connects RS-422 (DTE) to HSSI (DCE) Model 2040MT-MC-422*: Connects RS-422 (DCE) to HSSI (DTE) * RS-422 electrical signals are presented on a male connector
Cable:	6 feet (1.8 m)
Connectors:	Male HD/Slimline 50-pin (HSSI); Male M/34 (V.35)
Compliance:	FCC Class A, IEC CE (emissions).
Power:	Unit will require an external desk top power supply.
Temperature Range:	0 to 50° C (32 - 122°F)
Humidity:	5 to 95%, non-condensing
Size:	3.0"L x 1.8"W x 0.8"H (7.6 X 4.4 X 1.9 CM)
Approval:	CE (EMC Directive/EN 50082-1)

APPENDIX B

PATTON MODEL 2040 FACTORY REPLACEMENT PARTS AND ACCESSORIES

<u>Patton Model #</u>	<u>Description</u>
08055DCUI.....	100-240VAC (+5V ±5% reg. DC/2A) Universal Input Adapter
0805EUR.....	European Power Cord CEE 7
0805UK.....	United Kingdom Power Cord
0805US.....	American Power Cord
0805AUS.....	Australia/New Zealand Power Cord
0805DEN.....	Denmark Power Cord
0805FR.....	France/Belgium Power Cord
0805IN.....	India Power Cord
0805IS.....	Israel Power Cord
0805JAP.....	Japan Power Cord
0805SW.....	Switzerland Power Cord
07M2040-B.....	User Manual

APPENDIX C

Model 2040 HSSI Interface HD-50 Connector (DCE or DTE)

<u>Pin #</u>	<u>Signal</u>
1	SGND (Signal Ground)
26	SGND (Signal Ground)
2	RT (Receive Timing-A)
27	RT/ (Receive Timing-B)
3	DSR/(DCE Ready-A)
28	DSR (DCE Ready-B)
4	RD (Receive Data-A)
29	RD/ (Receive Data-B)
5	<i>Reserved for Future Use</i>
30	<i>Reserved for Future Use</i>
6	ST (Send Timing - A, DCE Source)
31	ST/ (Send Timing-B, DCE Source)
7	<i>Reserved for Future Use</i>
32	<i>Reserved for Future Use</i>
8	DTR (DTE Ready-A)
33	DTR/ (DTE Ready-B)
9	TT (Terminal Timing-A, DTE Source)
34	TT/ (Terminal Timing-B, DTE Source)
10	LA (Loopback A-A)
35	LA/ (Loopback A-B)
11	SD (Send Data A)
36	SD/ (Send Data B)
12	LB (Loopback B-A)
37	LB/ (Loopback B-B)
13	<i>Reserved for Future Use</i>
38	<i>Reserved for Future Use</i>
14 - 18	<i>Reserved for Future Use</i>
39 - 43	<i>Reserved for Future Use</i>
19	<i>Reserved for Future Use</i>
44	<i>Reserved for Future Use</i>
20 - 23	<i>Reserved for Future Use</i>
45 - 48	<i>Reserved for Future Use</i>
24	TM - Test Mode (Indication-A)
49	TM/ - Test Mode (Indication-B)
25	SGND (Signal Ground)
50	SGND (Signal Ground)

APPENDIX C

Model 2040 V.35 or RS-422 Interface* M/34 Connector (V.35 or RS-422 DCE or DTE)

<u>Pin #</u>	<u>Signal</u>
A	FGND (Frame Ground)
B	SGND (Signal Ground)
C	RTS (Request to Send)
D	CTS (Clear to Send)
E	DSR (Data Set Ready)
F	CD (Carrier Detect)
H	DTR (Data Terminal Ready)
L	LL (Local Loopback)
M	TM (Test Mode)
N	RL (Remote Loopback)
P	TD (Transmit Data)
R	RD (Receive Data)
S	TD/ (Transmit Data-B)
T	RD/ (Receive Data-B)
U	TT (Terminal Timing-A)
V	RT (Receive Timing-A)
W	TT/ (Terminal Timing-B)
X	RT/ (Receive Timing-B)
Y	ST (Send Timing-A)
AA	ST/ (Send Timing-B)

***NOTE:** The RS-422 versions of Model 2040 also use an M/34 connector. Please refer to Appendix D to construct your own cross-connect cable if your RS-422 device uses the RS-530 (DB-25) or RS-449 (DB-37) physical interface. You may also purchase cross-connect cables from Patton Electronics.

APPENDIX D

RS-422/RS-449 Interface DB-37 Connector

<u>Pin #</u>	<u>Signal</u>
1	Shield
4	TD
5	TC
6	RD
7	RTS
8	RC
9	CTS
11	DM (DSR)
12	TR (DTR)
13	RR (CD)
17	TT (XTC)
19	Signal Ground
20	Signal Ground
22	TD/
23	TC/
24	RD/
25	RTS/
26	RC/
27	CTS/
29	DM/ (DSR/)
30	TR/ (DTR/)
31	RR/ (CD/)
35	TT/ (XTC/)
37	Signal Ground

APPENDIX D

RS-422/RS-530 Interface

DB-25 Connector

Pin #	Signal
1	FG (Frame Ground)
2	TD (Transmit Data)
3	RD (Receive Data)
4	RTS (Request to Send)
5	CTS (Clear to Send)
6	DSR (Data Set Ready)
7	SGND (Signal Ground)
8	CD (Carrier Detect)
9	RC/ (Receive Timing-B)
10	CD/ (Carrier Detect-B)
11	XTC/ (External Transmit Clock)
12	TC/ (Test Control-B)
13	CTS/ (Clear to Send)
14	TD/ (Transmit Data-B)
15	TC (Test Control-A)
16	RD (Receive Data)
17	RC (Receive Timing)
18	LLB (Local Line Loop)
19	RTS/ (Request to Send)
20	DTR (Data Transfer Rate)
21	DL (Remote Digital Loop)
22	DSR/ (Data Set Ready)
23	DTR/ (Data Transfer Rate)
24	XTC (External Transmit Clock)
25	TM (Test Mode)

APPENDIX D

MODEL 2040MC-MT BLOCK DIAGRAM

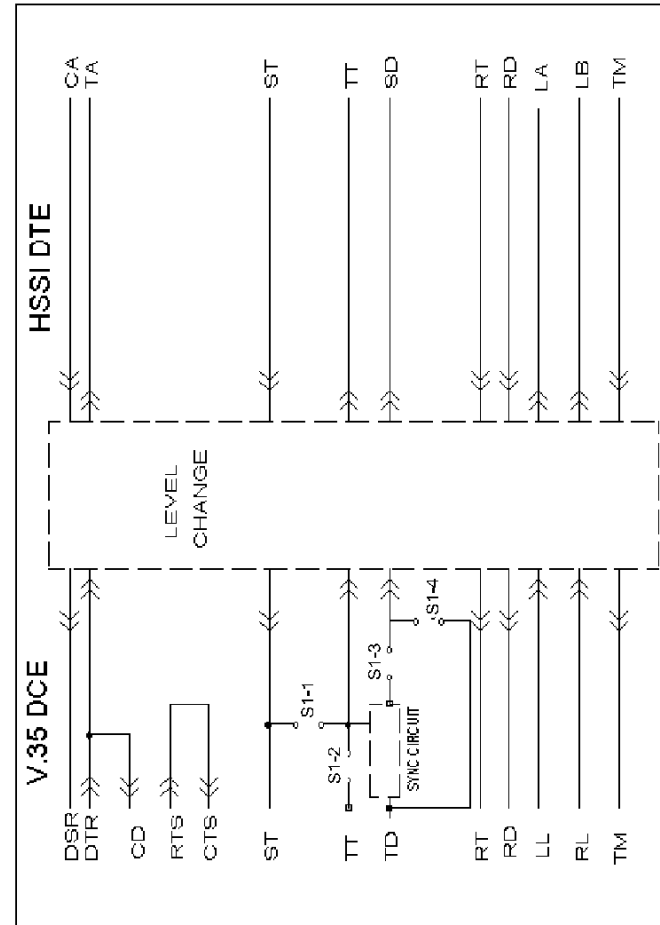

APPENDIX D

MODEL 2040MT-MC BLOCK DIAGRAM

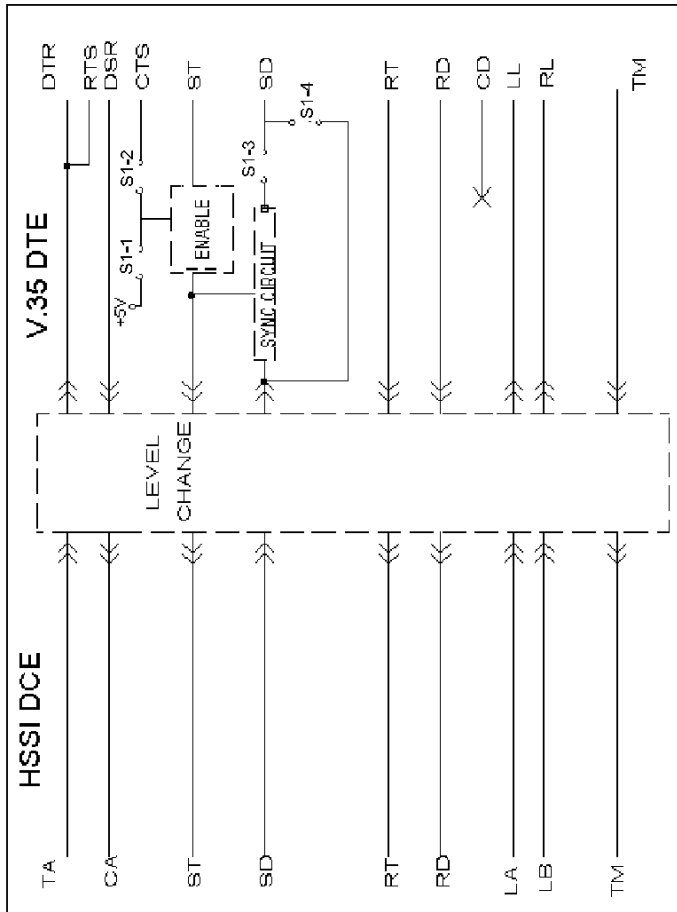

Dear Valued Customer,

Thank you for purchasing Patton Electronics products! We do appreciate your business. I trust that you find this user manual helpful.

We manufacture one of the widest selections of data communications products in the world including CSU/DSU's, network termination units, powered and self-powered short range modems, fiber optic modems, interface converters, baluns, electronic data switches, data-line surge protectors, multiplexers, transceivers, hubs, print servers and much more. We produce these products at our Gaithersburg, MD, USA, facility, and can custom manufacture products for your unique needs.